

GLC Coupé



Price list as of 1st June 2021

Mercedes-Benz



Welcome

At Mercedes-Benz we appreciate the importance of detail. Over the following pages you'll find model prices and a breakdown of standard and optional equipment, as well as details of the attractive finance offers and benefits that are available to every Mercedes-Benz driver.

We have highlighted some of the best styling features both inside and out, some of the new technology features and some body styling options which all combine to give you a unique driving experience. To experience a full listing of what is available; please speak directly to your local Mercedes-Benz Dealer.

Of course, some things have to be experienced to be truly appreciated, such as the qualities that set a Mercedes-Benz apart, which is why we'd like to invite you for a test drive at your local Mercedes-Benz Dealership. Discover the location and the contact details of your local Mercedes-Benz Dealership at www.mercedes-benz.ie

Contents

Model prices	4	AMG Line exterior equipment	25	Paintwork	32
Key equipment	14	Night package	26	Upholstery and trim	33
Equipment lines	18	Advantage package	27	Technical data	36
Standard interior equipment	21	Premium package	28	Dimensions	37
Standard exterior equipment	22	Premium Plus package	29	Mercedes Me	38
Exclusive interior equipment	23	Optional equipment	30		
AMG Line interior equipment	24	Wheels	31		

Price List

Petrol

Model Description	Wheel size	CO2	VRT Rate	Road Tax	CC	BHP	Price*
GLC 300 4MATIC Coupe Standard Interior / Standard Exterior	18"	171-190	31.00%	€600.00	1991	258	€75,735.00
GLC 300 4MATIC Coupe Exclusive Interior / Standard Exterior	18"	171-190	31.00%	€600.00	1991	258	€77,401.00
GLC 300 4MATIC Coupe AMG Line	19"	191 +	37.00%	€790.00	1991	258	€87,940.00
Mercedes-AMG GLC 43 4MATIC+ Coupe	19"	191 +	37.00%	€2,400.00	2996	367	€93,760.00
Mercedes-AMG GLC 63 S 4MATIC+ Coupe	20"	191 +	37.00%	€2,400.00	3982	510	€146,210.00

Plug In Hybrid

Model Description	Wheel size	CO2	VRT Rate	Road Tax	CC	BHP	Price*
GLC 300 e 4MATIC Coupe AMG Line Premium	19"	51-80	9.00%	€150.00	1991	**	€70,035.00
** 1,991cc, 4-cylinder, 211hp - Electric Motor 122hp. System Output 320hp.							

*Prices applicable to all models registered from 01st June to 31st July 2021. Subject to availability. Terms & Conditions apply. Prices quoted do not include dealer and delivery related charges.

Diesel

Model Description	Wheel size	CO2	VRT Rate	Road Tax	CC	BHP	Price*
GLC 220 d 4MATIC Coupe Standard Interior / Standard Exterior	18"	151-155	23.50%	€280.00	1950	194	€60,940.00
GLC 220 d 4MATIC Coupe Exclusive Interior / Standard Exterior	18"	151-155	23.50%	€280.00	1950	194	€62,459.00
GLC 220 d 4MATIC Coupe AMG Line	19"	156-170	26.00%	€420.00	1950	194	€67,865.00
GLC 300 d 4MATIC Coupe Standard Interior / Standard Exterior	18"	156-170	26.00%	€420.00	1950	245	€65,875.00
GLC 300 d 4MATIC Coupe Exclusive Interior / Standard Exterior	18"	156-170	26.00%	€420.00	1950	245	€67,440.00
GLC 300 d 4MATIC Coupe AMG Line	19"	171-190	31.00%	€600.00	1950	245	€75,527.00

Plug In Hybrid

Model Description	Wheel size	CO2	VRT Rate	Road Tax	CC	BHP	Price*
GLC 300 de 4MATIC Coupe AMG Line Premium	19"	51-80	9.00%	€150.00	1950	**	€71,545.00
** 1,950cc, 4-cylinder, 194hp - Electric Motor 122hp. System Output 306hp.							

*Prices applicable to all models registered from 01st June to 31st July 2021. Subject to availability. Terms & Conditions apply. Prices quoted do not include dealer and delivery related charges.

More than an SUV.
More than a coupé.
More than ever before.

Some personalities immediately make their mark. With their appearance. Their self-assurance. And their unique character. Much like the new GLC Coupé, which combines the merits of an SUV and a coupé like no other. In a style all of its own. More dynamic and sportier than ever.







Because communication is everything today.

The new GLC Coupé doesn't just listen to what you say, it also responds immediately to your touches and gestures – courtesy of MBUX, the sophisticated Mercedes-Benz User Experience with a wealth of new control and display features. Like the large media display with touch function or the fully digital instrument cluster with navigation display.

Something special. On every trip, from any angle.

More sporty than ever, the new GLC Coupé really catches the eye. With wider aprons, new tailpipe trims, and LED High Performance headlamps sporting a cutting-edge light design fitted as standard for the first time. The optional AMG Line and a host of new wheel designs take its unique sporty and elegant character to the highest level.



Take a seat and enjoy the view.

An exceptionally sporty and refined interior welcomes you on board. Large displays, smooth transitions and the finest new upholstery let you experience modern luxury with all the senses. Optional ENERGIZING packages give you new strength and energy while the optional Burmester® surround sound system indulges you with top-class sound.



The rear end: the start of something new.

The new GLC Coupé's rear end is eye-catchingly athletic and sporty. Powerful contours combine here with sensual, pure lines to dynamic effect. The impressive apron, the stylish chrome elements and the tailpipe trims integrated in the bumper all stand out here. The slender LED tail lights with cutting-edge light design are particularly striking.





Sit in an SUV. Drive a sports coupé.

Every metre and every second become a sporting event in the new GLC Coupé. You can make it even more agile with the optional DYNAMIC BODY CONTROL suspension, which lets you individualise the vehicle's damping and handling characteristics. At the touch of a button, for a noticeably more comfortable or more dynamic driving experience. Three options are available for this: "Comfort", "Sport" and "Sport+".

Energising comfort and exemplary safety.

During rush hour, on long drives at night, or on unfamiliar routes – your new GLC Coupé noticeably takes the strain out of driving, particularly in stressful situations. It's all down to a concept that makes every journey in a Mercedes-Benz a safer and unique experience: Mercedes-Benz Intelligent Drive. Because the time you spend behind the wheel is your time. Time for relaxation. Time to replenish your energy. So that, first and foremost, you reach your destination safely, but are also relaxed when you get there.



EQUIPMENT HIGHLIGHTS – DRIVING ASSISTANCE SYSTEMS

Driving Assistance package* Hit the road to autonomous driving: state-of-the-art systems assist you in many situations: adjusting the speed, steering, changing lanes, and even when there is a risk of a collision. The risk of an accident is reduced – passengers and road users are protected effectively. This way you are able to reach your destination relaxed and safe.

The innovative **PRE-SAFE® Sound*** system generates a sound signal through the loudspeakers that can trigger a protective reflex: your auditory system briefly disconnects, thereby protecting itself from the loud noise of a crash.

Parking package with 360° camera* Almost like having a valet on board. Active Parking Assist with 360° camera makes it easier for you to find a parking space and to manoeuvre into and out of parking spaces. Here the choice is yours: park with ease yourself thanks to all-round visibility – or make things even easier still by getting the car to park for you.

Mercedes-Benz User Experience.

In the new GLC Coupé, you can now control almost everything as intuitively as you do on your smartphone. Simply by using the large touchscreen, the new touchpad, or the Touch Control buttons on the new steering wheel. One touch is all it takes to adjust the display style, the ambient lighting, or the infotainment to meet your needs.

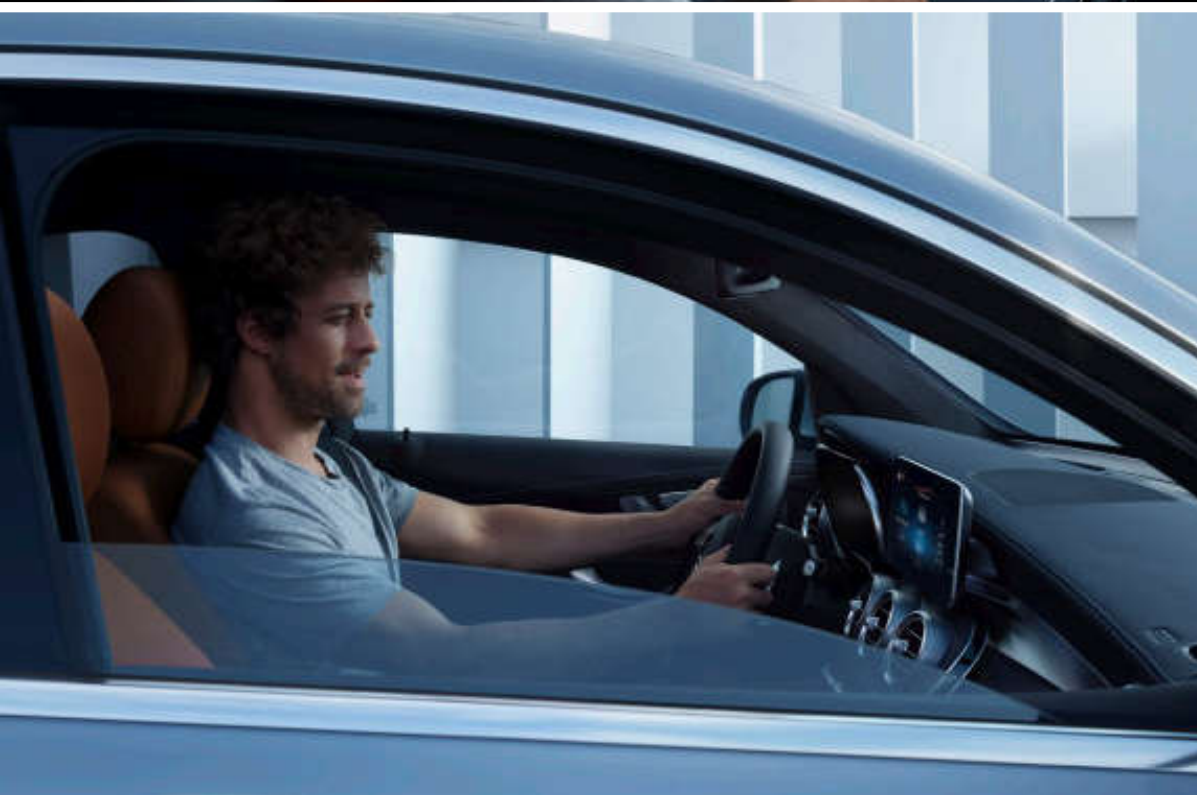

EQUIPMENT HIGHLIGHTS – CONTROL AND DISPLAY CONVENIENCE

MBUX Augmented Reality for Navigation* networks the virtual world with the real world to help you get your bearings in complex traffic situations. The technology incorporates graphical navigation instructions and traffic information into live images. You can get to your destination quickly, safely and stress-free.

With the **MBUX voice control** option, the new GLC Coupé not only listens to you, it hangs on your every word and talks to you. You can converse with your car in a perfectly natural manner to adjust and control virtually all the functions in the car. Simply say “Hey Mercedes”, and the new GLC Coupé will be all ears.

MBUX Interior Assistant* Enjoy touchless ease of operation: this innovative system records and interprets your hand and arm movements, meaning that you can activate certain functions in next to no time. The system is able to distinguish between driver and front passenger – so you can access exactly the menus you want.

*Optional Equipment



Fully digital instrument cluster.*

The fully digital instrument display with the display styles “Classic”, “Progressive” and “Sporty” enables you to decide which information is important to you and in which way you wish to have it displayed. The 31.2 cm (12.3-inch) display delivers a pin-sharp image which is very easy to read in all light conditions.

*Optional equipment



Burmester® surround sound system.*

With the optional Burmester® surround sound system your new GLC Coupé becomes a concert hall. 13 high-performance speakers, a 9-channel DSP amplifier, a total system output of 590 W, and electronic and acoustic elements tailored precisely to the interior conjure up a unique sound. The surround function and the sound optimisation for the front and rear seats provide an even more intensive listening experience.



MULTIBEAM LED headlamps.*

Perfect visibility for you: the adaptive MULTIBEAM LED headlamps have individually controllable LEDs that react to the traffic situation. Partial main beam shines past other road users without dazzling them. ULTRA RANGE main beam increases the range to the permitted maximum. The Active Light System and cornering lights further optimise illumination of the way ahead.

*Optional equipment



Sporty wheel design.*

There's no stopping the new GLC Coupé – it is forever evolving. An even broader range of exclusive wheels is now available, offering a host of new rim designs. From 18 inches to 20 inches, from elegant to sporty: the choice is yours.

Standard equipment and appointments.

A stylish exterior already comes as standard, including exclusive design features in chrome and attractive light-alloy wheels. The visible, chrome-plated tailpipe trims emphasise the vehicle's dynamic look.



The Exclusive interior equipment line.

The Exclusive interior allows you to show what matters to you: the utmost in elegance and top-class quality down to the most minute detail. The luxurious highlights and the refined ambience of your interior, including exclusively designed seats and a high-quality dashboard trim, will continue to delight each day.



The AMG Line.

The expressive AMG Line styling lends the exterior a sporty, exclusive touch – your clear statement for powerful design. On top of this, the technical features give palpably more fun at the wheel, since the agile configuration of the sports suspension with Sports Direct-Steer makes the handling noticeably dynamic.



The Night package.

The Night package adds attractive touches: many of the exterior features are finished in black. They underscore the sporty character and special individuality of your vehicle, enabling you to demonstrate your sense of expressive design and exclusive sportiness.





4MATIC all-wheel drive.*

On tarmac or light off-road terrain: 4MATIC lets the new GLC Coupé show its impressive strength in adverse weather conditions such as rain, black ice or snow. Thanks to the interplay between the individual wheels, the permanent all-wheel drive is able to ensure exemplary driving stability and traction at all times. For greater dynamism, comfort and safety overall.

*Optional equipment

GLC

Standard interior equipment

3-spoke multifunction sports steering wheel in black leather with black topstitching and two-piece bezel on the front in silver chrome

Air vents with external adapter tubes and front face of the louvres in high-gloss black, nozzle ring and rotary knob in silver chrome

ARTICO man-made leather upholstery

Door centre panels in black ARTICO man-made leather

DAB Digital Radio

Extended MBUX functions

Fabric roof liner in porcelain or black

Heated front seats

Horizontal trim element in the instrument panel in silver chrome, trim element in the centre console and in the doors in a high-gloss black piano-lacquer look

Instrument cluster with 2 circular instruments and 5.5" multifunction display

Instrument panel in black

Interior Light package

KEYLESS GO starting function

Live Traffic Information

Rain sensor

Reversing camera

Seat belts in black

Seat Comfort package

Sound system, comprising 4 midrange speakers and 1 woofer, each with an output of 25 W

Stowage Space package

Touchpad

Velour floor mats



GLC

Standard exterior equipment

18" light-alloy wheels in a 5-triple-spoke design

Chrome package, consisting of:

- 2 visible tailpipe trim elements integrated into the bumper
 - Beltline trim strips in polished aluminium
 - Polished aluminium roof railing, flush-fitted
 - Window weatherstrip in polished aluminium
 - Radiator trim with integral Mercedes star and two louvres in matt iridium silver with chrome inserts
 - Simulated underguard at front and rear in chrome
-

EASY-PACK tailgate

Heat-insulating dark-tinted glass

LED High Performance headlamps



GLC

Exclusive interior equipment

3-spoke multifunction sports steering wheel in black leather with black topstitching and two-piece bezel on the front in silver chrome

Air vents with outer adapter tubes in Nürburg silver, vent surround, rotary knob and front face of the louvres in silver chrome

ARTICO man-made leather upholstery

Door centre panels in ARTICO man-made leather in black with mid-grey topstitching

Extended MBUX functions

Fabric roof liner in beige or black

Heated front seats

Horizontal trim element in the instrument panel galvanised in silver chrome, high-gloss brown line structure lime wood trim in the centre console and in the doors

Instrument cluster with 2 tube-shaped circular instruments, 5.5" multifunction display and surround in silver chrome

Instrument panel and door beltlines in ARTICO man-made leather in black

Interior Light package

KEYLESS GO starting function

Live Traffic Information

Rain sensor

Reversing camera

Seat Comfort package

Stowage Space package

Touchpad

Velour floor mats



GLC

AMG Line interior equipment

3-spoke multifunction sports steering wheel in black nappa leather, with black topstitching, flattened bottom section, heavily embossed in the grip area, with Touch Control buttons and steering wheel bezel in galvanised silver chrome

Air vents with external adapter tubes and front face of the louvres in high-gloss black, nozzle ring and rotary knob in silver chrome

AMG brushed stainless steel sports pedals with black rubber studs

ARTICO man-made leather upholstery

Door centre panels in ARTICO man-made leather with special AMG Line contrasting topstitching

Extended MBUX functions

Floor mats in black with "AMG" lettering

Heated front seats

Horizontal trim element in the instrument panel in light longitudinal-grain aluminium

Instrument cluster with 2 tube-shaped circular instruments including 5.5" multifunction display and surround in silver chrome

Interior Light package

KEYLESS GO starting function

Large trim element in a piano-lacquer look in the centre console

Live Traffic Information

Rain sensor

Reversing camera

Roof liner in black fabric

Seat Comfort package

Stowage Space package

Touchpad

Trim elements in the doors in light longitudinal-grain aluminium



GLC

AMG Line from* €5,085

19" AMG 5-twin-spoke light-alloy wheels

2 visible tailpipe trim elements integrated into the bumper

AMG bodystyling consisting of AMG front apron with sporty air intakes and chrome trim element, AMG diffuser-look rear apron with insert in black

Diamond radiator grille with pins in chrome with integrated Mercedes star and single louvre in matt iridium silver with chrome insert

EASY-PACK tailgate

Front brakes with perforated brake discs and black "Mercedes-Benz" lettering on the brake calliper

Heat-insulating dark-tinted glass

LED High Performance headlamps

Sports suspension with sports Direct Steer



Optional equipment shown 20" AMG light-alloy wheels painted in titanium grey and with a high-sheen finish (92R)

GLC

Night package* from €262

19" 6-spoke light-alloy wheels, painted in black with a high-sheen finish
(with Standard exterior)

19" AMG 5-spoke light-alloy wheels painted in high-gloss black with a high-sheen finish (with AMG Line exterior)

Optional: 20" AMG 5-twin-spoke light-alloy wheels painted in high-gloss black with a high-sheen finish (with AMG Line exterior)

Optional: 20" AMG multi-spoke light-alloy wheels painted in high-gloss black with a high-sheen finish (with AMG Line exterior)

Beltline trim strip and window weatherstrip in high-gloss black

Exterior mirror housings painted in high-gloss black

Heat-insulating, dark-tinted glass in the rear from B-pillars

Radiator grille with 2 louvres in high-gloss black with chrome inserts
(with Standard exterior)

Radiator grille with diamond radiator grille with silver-coloured pins and louvre in high-gloss black (with AMG Line exterior)

Underguard at front and rear painted in black



GLC

Advantage package from* €4,096

10.25" Media display

Mirror package

Navigation Connectivity package

Parking package with reversing camera



GLC

Premium package from* €9,620 (Standard for PHEV)

10.25" Media display

Advanced Sound System - 9 speakers, 225 watts

All-digital instrument display

Ambient lighting

Mirror package

MULTIBEAM LED

Navigation Connectivity package

Parking package with reversing camera

Smartphone integration

Traffic Sign Assist

Wireless charging system for mobile devices



GLC

Premium Plus package from* €13,165

10.25" Media display

All-digital instrument display

Ambient lighting

Burmester® surround sound system - 13 speakers, 590 watts

KEYLESS-GO Comfort package

Mirror package

MULTIBEAM LED

Navigation Connectivity package

Sliding sunroof

Parking Package with 360-degree camera

Smartphone integration

Traffic Sign Assist

Wireless charging system for mobile devices



GLC

Optional equipment

	From*
AIR BODY CONTROL	€3,846
All-digital instrument display (Requires Advantage package)	€1,519
Aluminium-look running boards with rubber studs	€953
Driving Assistance package	€4,251
Head-up Display	€2,006
Leather upholstery	€2,916
Metallic paint	€1,619
MULTIBEAM LED	€2,632
Multicontour Seat package	€791
Parking Package with 360° camera	€2,208
Smartphone integration	€709
THERMOTRONIC automatic climate control	€1,196
Trailer coupling with ESP® trailer stabilisation	€1,943
Wireless charging system for mobile devices	€405



*Optional equipment prices are subject to model selected.

Standard Wheels

AMG Line Wheels

Standard



64R – 18" 5-twin-spoke AERO



RZF - 19" AMG 5-twin-spoke light-alloy wheels - **Standard**



RZG – 19" AMG 5-twin-spoke light-alloy wheels – **Standard with Night Package**

Optional



97R – 18" 5-twin-spoke alloy



92R – 20" AMG light-alloy wheels - **Optional**



93R – 20" AMG light-alloy wheels - **Optional with Night Package**



RTG – 19" AMG 5-twin-spoke light-alloy wheels – **Optional with Night Package**



15R – 19" multi-twin-spoke allo



RZX – 20" AMG 5-twin-spoke light-alloy wheels - **Optional**



RZY - 20" AMG 5-twin-spoke light-alloy wheels - **Optional with Night Package**

Paintwork

Non-metallic paints

- 040 black
149 polar white
-

Metallic paints¹

- 197 obsidian black
831U graphite grey
831 graphite grey
859 mojave silver
992U high-tech silver
970 spectral blue
992 selenite grey
-

designo paints¹

- 297 designo selenite grey magno
799 designo diamond white bright
996 designo hyacinth red metallic
-

Non-metallic paints

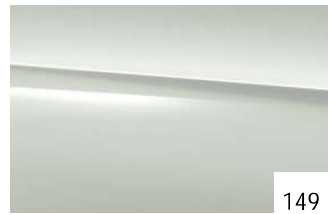
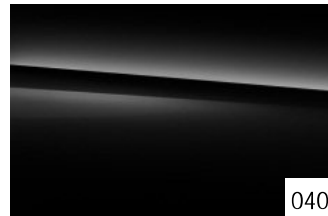

Metallic paints

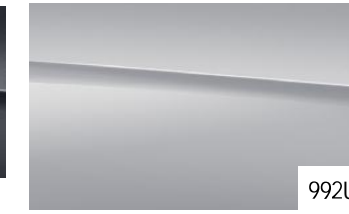
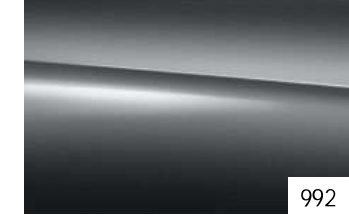
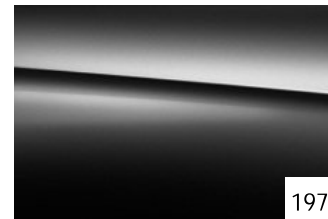

designo paints

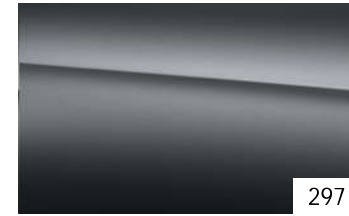

¹ Optional extra.

Trims

Standard

Base Int.



H80 – black piano-lacquer look trim

Exclusive Int.



H07 – dark brown glossy linden wood trim

AMG Line Int.



739 – black piano lacquer w. aluminium

Optional (open for all lines)



H07 - dark brown glossy linden wood trim



H31 – open pore wood oak



H33 – open pore walnut wood



739+737 – centre console black ash wood, aluminium door inlays



736 – open pore black ash wood



H09 – open pore brown ash wood



H73 – Carbon aluminium

Upholstery - Standard Interior



101A – ARTICO Black

Dashboard
Seat
Carpet
Roofliner



Standard
No cost option



115A – ARTICO silk beige/black



Optional Extra
Chargeable item



128A – ARTICO magma grey



Optional Extra
Chargeable item



221A – LEATHER Black



Optional Extra
Chargeable item



235A – LEATHER silk beige/black



Optional Extra
Chargeable item



228A – LEATHER magma grey



Optional Extra
Chargeable item

Upholstery - Exclusive Interior



101A – ARTICO Black

Dashboard
Seat
Carpet
Roofliner



Standard
No cost option



105A – ARTICO silk beige/espresso



Optional Extra
Chargeable item



128A – ARTICO magma grey



Optional Extra
Chargeable item



221A – LEATHER Black



Optional Extra
Chargeable item



225A – LEATHER silk beige/espresso

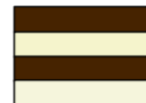

Optional Extra
Chargeable item

Upholstery – AMG Line

Standard



161A – ARTICO Black



631A – ARTICO man-made leather / DINAMICA microfibre - black

Dashboard	
Seat	
Carpet	
Roofliner	

Optional Extra





197A – ARTICO cranberry red/black







164A – ARTICO saddle brown







261A – LEATHER Black
Optional Extra Chargeable item





297A – LEATHER cranberry red/black
Optional Extra Chargeable item





264A – LEATHER saddle brown
Optional Extra Chargeable item



Technical data.

Displacement (cc)
Rated output ¹ (kW [HP] at rpm)
Acceleration from 0 to 100 km/h (s)
Top speed (km/h)
Fuel consumption ⁴ (l/100 km)
Urban
Extra-urban
Combined
Combined CO ₂ emissions ⁴ (g/km)
Emissions class ⁵ /efficiency class ⁶

Displacement (cc)
Rated output ¹ (kW [HP] at rpm)
Acceleration from 0 to 100 km/h (s)
Top speed (km/h)
Fuel consumption ⁴ (l/100 km)
Urban
Extra-urban
Combined
Combined CO ₂ emissions ⁴ (g/km)
Emissions class ⁵ /efficiency class ⁶

Petrol Engines

300 4MATIC Coupé	63 4MATIC+Coupé	63 S 4MATIC+ Coupé
1991	3982	3982
190 [258]/5800-6100	350 [476]/5500-6250	375 [510]/5500-6250
6.3	4	3.8
240 ³	270 ³	280 ³
9.6 - 8.9	16.8 - 17.4	16.8 - 17.1
7.3 - 6.0	9.5 - 9.0	9.5 - 9.2
8.1 - 7.1	12.3 - 12.1	12.3 - 12.2
186 - 161	280 - 275	280 - 277
Euro 6d-TEMP-EVAP-ISC	Euro 6d-TEMP-EVAP-ISC	Euro 6d-TEMP-EVAP-ISC

Diesel engines

200d Coupé	200d 4MATIC Coupé	220d 4MATIC Coupé	300d 4MATIC Coupé
1950	1950	1950	1950
120 [163]/3200-4600	120 [163]/3200-4600	143 [194]/3800	180 [245]/4200
8.7	8.9	7.9	6.6
208 ³	206 ³	217 ³	23 ³
6.3 - 6.1	6.5 - 5.8	6.5 - 5.8	7.4 - 7.0
4.7 - 4.4	5.7 - 4.9	5.7 - 4.9	5.4 - 5.0
5.3 - 5.1	6.0 - 5.2	6.0 - 5.2	6.0 - 5.8
140 - 133	158 - 137	158 - 137	159 - 152
Euro 6d ISC	Euro 6d ISC	Euro 6d ISC	Euro 6d ISC

The best for the engine:
Mercedes-Benz genuine engine oils.

¹ Figures for rated output in accordance with Regulation (EC) No. 715/2007 in the currently applicable version. ² Available for a brief period. ³ Electronically limited. ⁴ The figures shown were calculated according to the prescribed measuring method. They constitute the "NEDC CO₂ figures" pursuant to Article 2 No. 1 Implementing Regulation (EU) 2017/1153. Fuel consumption figures have been calculated on this basis. More information about the official fuel consumption and the official specific CO₂ emissions of new passenger cars is available in the publication entitled "Leitfaden über den Kraftstoffverbrauch, die CO₂-Emissionen und den Stromverbrauch neuer Personenkraftwagen" ["Guidelines concerning the fuel consumption, CO₂ emissions and electricity consumption of new passenger cars"], available free of charge at all retailers and from Deutsche Automobil Treuhand GmbH at www.dat.de. The figures are not based on an individual vehicle and do not constitute part of the product offer; they are provided solely for purposes of comparison between different vehicle models. The figures will vary according to the optional features selected.

⁵ Only valid within the European Union. Details may vary from country to country. ⁶ Calculated on the basis of the CO₂ emissions measured, taking into account the mass of the vehicle. Only valid for Germany. For more technical

Dimensions.

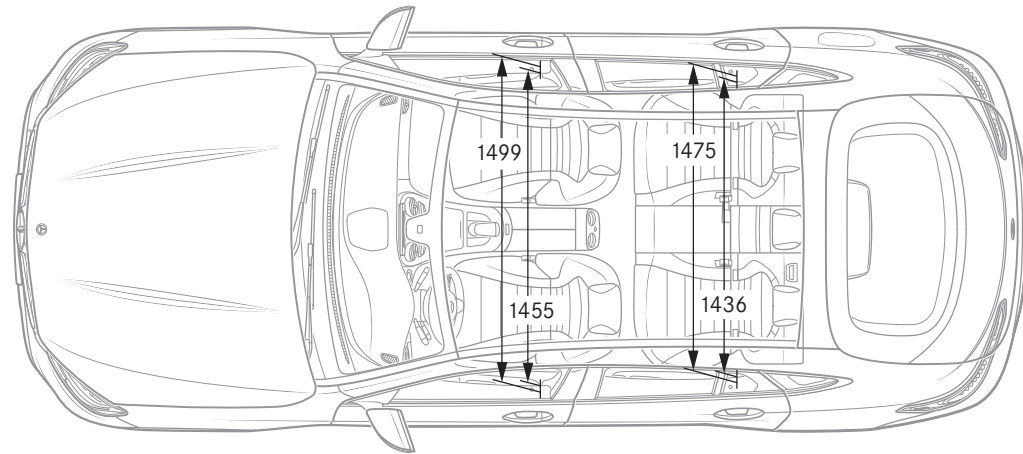
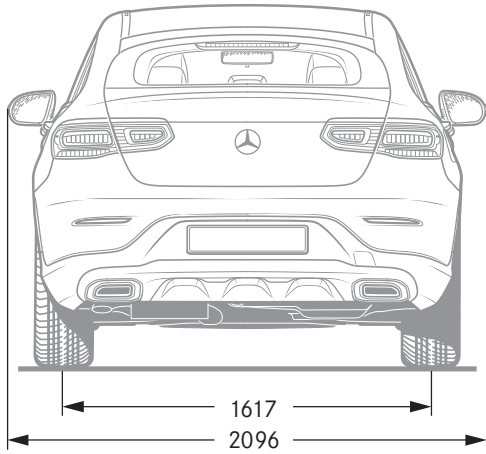
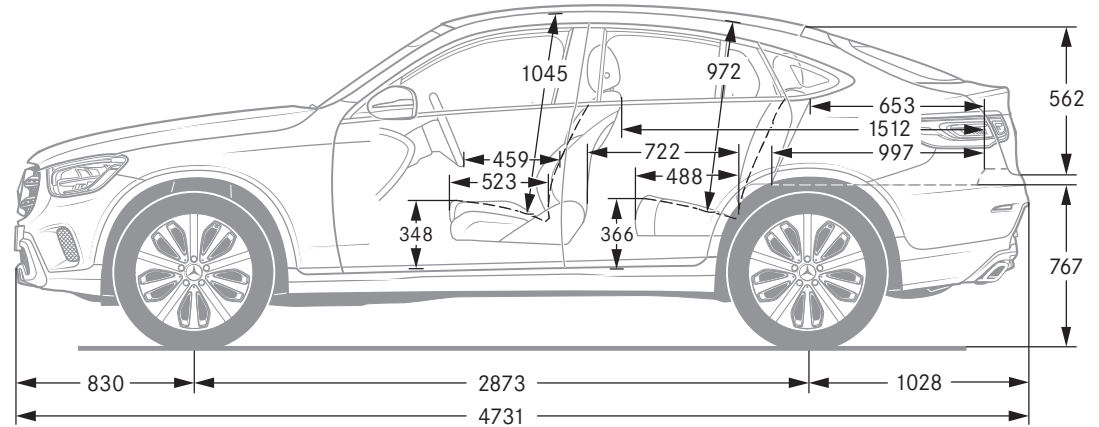
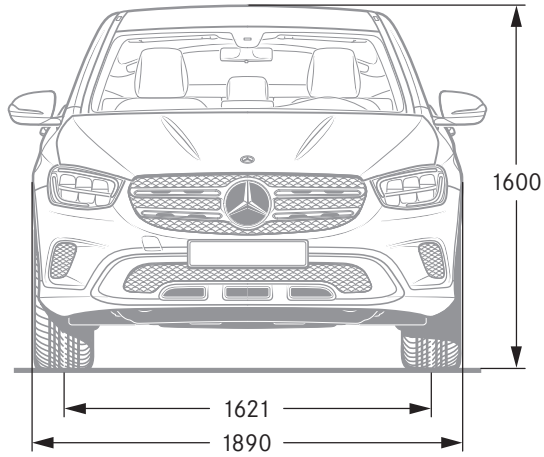

All figures in millimetres. The illustrated dimensions are mean values. They are valid for vehicles in basic specification and in unladen condition.

Mercedes me

Welcome to your Mercedes-Benz world.

Imagine if ...you could connect with your Mercedes-Benz? With Mercedes me connect, you can! Mercedes me connect offers you new connectivity services that make driving more comfortable and incorporates your car into your personal lifestyle.

Standard Services

- Maintenance Management
- Telediagnosics
- Breakdown Management
- Accident Recovery
- Mercedes-Benz Emergency Call System

Remote Online Services¹

- Remote Retrieval of Vehicle Status (fuel level, tyre pressure etc.)
- Parked Vehicle Locator
- Vehicle Tracker
- Geofencing
- Door lock / unlock function

¹ Can be used with Remote Online special feature.



Getting connected is easy. Just set up your Mercedes me account and get in touch with your Mercedes-Benz dealer to connect your vehicle to your profile to access your Mercedes me connect services.

Contact your dealer to get connected, or go to www.mercedes.me for more details.

Follow us on the following social media channels:

 facebook.com/MercedesBenzIreland

 instagram.com/mercedesbenz_ireland

 [linkedin.com/company/motor distributors ltd](https://linkedin.com/company/motor-distributors-ltd)

 twitter.com/MB_IRELAND

 youtube.com/mercedesbenzireland

 pinterest.com/mercedesbenzire

Motor Distributors Ltd.
Naas Road
Dublin 12
Ireland
www.mercedes-benz.ie

Information correct at time of going to print. Prices and specifications are subject to change without prior notice. Prices quoted do not include dealer and delivery related charges. Images are for illustrative purposes only, actual product may vary. For more specific information in relation to the range of models, features, optional extras, colours and services available please speak to your local authorised Mercedes-Benz dealer.