

The GLE

Sport Utility Vehicle



Price list as of 1st April 2021

Mercedes-Benz



Welcome

At Mercedes-Benz we appreciate the importance of detail. Over the following pages you'll find model prices and a breakdown of standard and optional equipment, as well as details of the attractive finance offers and benefits that are available to every Mercedes-Benz driver.

We have highlighted some of the best styling features both inside and out, some of the new technology features and some body styling options which all combine to give you a unique driving experience. To experience a full listing of what is available; please speak directly to your local Mercedes-Benz Dealer.

Of course, some things have to be experienced to be truly appreciated, such as the qualities that set a Mercedes-Benz apart, which is why we'd like to invite you for a test drive at your local Mercedes-Benz Dealership. Discover the location and the contact details of your local Mercedes-Benz Dealership at **www.mercedes-benz.ie**

Contents

Model prices	4	7-Seater package	30	Upholstery & Trim	37
Star Finance PCP	5	Night package	31	Technical data	38
Key equipment	18-25	Premium package	32	Dimensions	39
Standard interior equipment	26	Premium Plus package	33	Mercedes Me	40
Standard exterior equipment	27	Optional Equipment	34		
AMG Line interior	28	Wheels	35		
AMG Line exterior	29	Paintwork	36		

Price List

Petrol

Model Description	Wheel size	CO2	VRT Rate	Road Tax	CC	BHP	Price*
GLE 450 4MATIC	19"	191 +	37.00%	€1,250	2999	367	€104,160
GLE 450 4MATIC Standard Interior / AMG Line Exterior	20"	191 +	37.00%	€1,250	2999	367	€111,617
GLE 450 4MATIC AMG Line	20"	191 +	37.00%	€1,250	2999	367	€112,363

Diesel

Model Description	Wheel size	CO2	VRT Rate	Road Tax	CC	BHP	Price*
GLE 300 d 4MATIC	18"	171-190	31.00%	€600	1950	245	€84,920
GLE 300 d 4MATIC Standard Interior / AMG Line Exterior	20"	191 +	37.00%	€790	1950	245	€100,204
GLE 300 d 4MATIC AMG Line	20"	191 +	37.00%	€790	1950	245	€100,950
GLE 350 d 4MATIC	18"	171-190	31.00%	€600	2925	272	€89,035
GLE 350 d 4MATIC Standard Interior / AMG Line Exterior	20"	191 +	37.00%	€1,250	2925	272	€104,669
GLE 350 d 4MATIC AMG Line	20"	191 +	37.00%	€1,250	2925	272	€105,415
GLE 400 d 4MATIC	19"	171-190	31.00%	€600	2925	330	€98,845
GLE 400 d 4MATIC Standard Interior / AMG Line Exterior	20"	191 +	37.00%	€1,250	2925	330	€115,299
GLE 400 d 4MATIC AMG Line	20"	191 +	37.00%	€1,250	2925	330	€116,045

*Prices applicable to all models registered from 01st April to 30th June 2021. Subject to availability. Terms & Conditions apply. Prices quoted do not include dealer and delivery related charges.

Diesel Hybrid

Model Description	Wheel size	CO2	VRT Rate	Road Tax	CC	BHP	Price*
GLE 350 de 4MATIC	19"	0-50	7.00%	€140	1950	**	€86,930
GLE 350 de 4MATIC Standard Interior / AMG Line Exterior	20"	0-50	7.00%	€140	1950	**	€92,696
GLE 350 de 4MATIC AMG Line	20"	0-50	7.00%	€140	1950	**	€93,222
** 1,950cc, 4-cylinder, 194hp - Electric Motor 136hp							

AMG

Model Description	Wheel size	CO2	VRT Rate	Road Tax	CC	BHP	Price*
Mercedes-AMG GLE 53 AMG 4MATIC+	20"	191 +	37.00%	€2,400	2999	435	€133,930
Mercedes-AMG GLE 63 AMG 4MATIC+	20"	191 +	37.00%	€2,400	3982	571	€181,405
Mercedes-AMG GLE 63 S AMG 4MATIC+	21"	191 +	37.00%	€2,400	3982	612	€197,220

*Prices applicable to all models registered from 01st April to 30th June 2021. Subject to availability. Terms & Conditions apply. Prices quoted do not include dealer and delivery related charges.

Star Finance PCP

You said you'd drive a Mercedes-Benz one day. One day is now with Star Finance PCP.

Speak to your dealer to discover just how easy it can be to upgrade from the ordinary to the extraordinary.

Our new Personal Contract Plan guarantees the minimum future value (GMFV) of your Mercedes-Benz.

Select your Mercedes-Benz model, pay your deposit and in 37 months either:

Trade-in for a brand new model

Acquire your model by paying the outstanding balance

Return the car and walk away (T&C's apply)

Mercedes-Benz GLE Star Finance PCP Example (includes delivery and a 3 year service plan)

Purchase Price†:	€86,320.00
Deposit/Trade in:	€25,896.00
Finance Amount:	€60,424.00
36 Monthly Payments of:	€1,046.83
GMFV ^{††} (Optional Final Payment)	€29,348.80
Term:	37 months
Total Cost of Credit:	€7,721.00
APR %*	4.9%

Terms and Conditions.

†Includes delivery & related charges. Model is shown for illustrative purposes only. †† The Guaranteed Minimum Future Value (GMFV) is payable if you renew or retain the vehicle at the end of the agreement. Further charges may be applied by your Mercedes-Benz Dealer subject to kilometre limits/condition of the vehicle. *Lending criteria and conditions apply. Fixed APR (Annual Percentage Rate) 4.9% which is inclusive of a documentation fee of €63.49. To qualify for this Finance Offer; a minimum deposit of 10% is required. Rate quoted is correct as at 01st March 2021 and subject to change. Offer available on all new GLE 300d 4MATIC diesel models registered from 01st March to 31st March 2021 at authorised dealers. This is a Consumer Hire Purchase agreement provided by Bank of Ireland t/a Bank of Ireland Finance. CO2 range: 169-161 g/km and 6.4-6.1 l/100 km

A black SUV is driving away from the viewer on a two-lane asphalt road in a desert landscape. The road has white lane markings and a large white 'STOP' sign painted on the pavement. In the distance, a railroad crossing with two red lights and a white barrier is visible. The background features rolling mountains under a blue sky with scattered white clouds. Utility poles and power lines are visible along the road.

The shape of success.
In a whole new dimension.

More intelligent and attentive than ever – the new GLE casts the SUV in a whole new light. Its suspension actively smooths out any unevenness and its infotainment system learns more about your preferences as the days go by. Its convenience systems, meanwhile, can recognise when you need to take a rest.







Consistency all down the line.

Take a step back at the right moment and then be right there when it matters the next moment – that is the art of the GLE design. Only the distinctive AMG Line and wheels up to 22 inches in size can make it sportier. This expression of clarity and dynamism is typical of Mercedes-Benz design today.



Follow your intuition.

The new GLE is the first SUV to feature the revolutionary MBUX infotainment system. Highlights here include a natural-language voice control system, a range of touch controls and the ability to learn more about the habits and preferences of the driver with each journey.





More space for inner greatness.

For the first time, the GLE is now available with a third seat row with two full-size seats. Access to the third row is easy, while the flexibility provided by an adjustable second seat row makes the footwell very adaptable. And what's even better is that the improved spatial concept of the new GLC still provides more legroom and comfort in the rear.

The embodiment of calm.

Keeping things calm can sometimes take a lot of effort. Under tricky circumstances, it's something achieved by only a few people and only one SUV: the new GLE with E-ACTIVE BODY CONTROL fully active suspension. It is able to adapt in a split second to the road surface ahead.





S UV 1672





The new GLE simply oozes serenity.

Sensual surfaces, muscular contouring and clear lines define the design of the new GLE. It is hard to imagine a more elegant and dynamic expression of power.

MBUX Augmented Reality for navigation.

Thanks to Augmented Video it is easier to find your way around the navigation environment. The sophisticated system facilitates orientation by linking the virtual and real worlds: graphical navigation instructions and traffic information are incorporated into live images. This helps you to get to your destination quickly and stress-free.



ENERGIZING COACH.

The new optional ENERGIZING COACH can noticeably relax or invigorate the driver. For this purpose, it employs software which combines the data from a fitness tracker with various comfort systems in the vehicle.



*Optional equipment.

Trailer Manoeuvring Assist.

Save time and spare your nerves when manoeuvring: With the Trailer Manoeuvring Assist you can complete reversing manoeuvres calmly, confidently and precisely – even in difficult situations. For inexperienced drivers of car / trailer combinations in particular, the assisted steering is a genuine help.



Head-up display.

The best outlook for sporty driving enjoyment and an assured driving experience: the head-up display transforms your windscreen into a stunning digital cockpit. As such you always have a direct view of key information. Your full attention remains on the road and the traffic conditions in front of you.



*Optional equipment.



Third seat row.

For the first time, the GLE is now available with a third seat row with two full-size seats. Access to the third row is easy, while the flexibility provided by an adjustable second seat row makes the footwell very adaptable.

Rear seats electrically adjustable.

The electrically adjustable second seat row brings a convenient level of flexibility: extend the load space at the simple touch of a button and position the rear seats as you require them. It all makes for a quick and easy way to create extra load capacity.

*Optional equipment.



Widescreen Cockpit.

Design that impresses, right from the start: the elegant Widescreen Cockpit. And the more you explore, the better it gets: choose between various display styles, follow the navigation guidance provided by MBUX Augmented Reality, position the displays as you want them. All on two large 31.2 cm (12.3-inch) displays under a stylish glass cover.

*Optional equipment.

Burmester® high-end 3D surround sound system.

An audio experience comparable with that of a top-end home music system. Loudspeakers within the roof liner compose a three-dimensional sound. You conduct the system as if it were your personal orchestra – with VIP settings for specific seats or stylistic requests such as “Live” or “Easy Listening”. Perfection in design and engineering: the extendable tweeters.

Standard equipment and appointments.

Powerful vehicle with powerful character: the exterior conveys strength and elegance. Its generous proportions exude poised assurance and a sense of safety.

The progressively styled interior represents the epitome of sporty elegance. Generous dimensions, high-quality materials and numerous practical details provide the basis for a luxurious ambience and genuinely comfortable travel.



The AMG Line equipment line.

The optional AMG Line adds a shine with a sparkling diamond radiator grille. Sporty aprons all round, large air inlets, painted wheel arch liners and special light-alloy wheels demonstrate sporting style.

AMG Line features add a touch of racing style to the interior and support dynamic driving.

Night Package.

Added character – expressive style. In combination with the AMG Line, the Night Package adds striking highlights in the form of exclusive black design features. These accentuate the sporty character and athletic design idiom of your vehicle. Ideal for individualists with a true appreciation of expressive design.





Driving Assistance Plus Package.

The optionally available Driving Assistance Plus Package tangibly reduces the strain on the driver, particularly on long trips but also in confusing urban traffic. The new GLE is available with the very latest generation of this package, which can now provide support in even more driving situations: for example in a traffic jam or in advance of bends,

roundabouts or junctions. The new GLE can now even follow the vehicle in front autonomously in stop-and-go traffic. This also relieves the driver of the bothersome task of restarting after each stop.

*Optional equipment.



E-ACTIVE BODY CONTROL fully active suspension.

With the new E-ACTIVE BODY CONTROL fully active air suspension we are pooling our most innovative and intelligent suspension technologies to create a mesmerising driving experience.

In “Curve” mode, the vehicle can actively lean into a bend. This minimises the transverse force and tangibly increases comfort and dynamism. In “Comfort” mode, the ROAD SURFACE SCAN with stereo camera scans the road ahead of the vehicle¹. The suspension struts are then activated so as to substantially reduce the body movements when driving over bumps in the road.

¹ In conjunction with the Driving Assistance Plus Package.

GLE

Standard interior equipment

4-way lumbar support for driver's seat

Active Brake Assist

Active Lane Keeping Assist

Adaptive Highbeam Assist

Additional USB ports

Ambient lighting featuring 64 colours

Brushed aluminium trim with light longitudinal grain (other trims optionally available)

Blind Spot Assist

Cruise control

EASY-PACK tailgate and load compartment cover

Electrically adjustable front seats

Extended navigation services

Front door sill panels with "Mercedes-Benz" lettering

Hard-disc navigation with Live Traffic Information

Heated front seats

Interior Chrome package

KEYLESS-GO starting function

Kneebag for driver

Leather upholstery

MBUX multimedia system with LINGUATRONIC (with natural speech recognition, "Hey Mercedes"), Dual Phone mode, Internet radio, Bluetooth telephony / audio and Touch Control buttons and finger navigation pads on the steering wheel

Mercedes me connect

Mercedes-Benz emergency call system

Multifunction sports steering wheel in nappa leather

Parking package with reversing camera

Private car sharing

Roof liner in crystal grey fabric

THERMATIC 2-zone automatic climate control

Traffic Sign Assist

Widescreen Cockpit with 2 displays (each with a screen diagonal of 12.3 inches)

Wireless charging system for mobile devices

GLE

Standard exterior

18" / 19" light-alloy wheels depending on engine choice

4MATIC with Torque on Demand (dependent on engine variant)

Exhaust system with 2 chrome-plated tailpipe trim elements

Heat-insulating dark-tinted glass

LED High Performance headlamps and LED tail lights

Mirror package

Radiator trim with 2 chrome-plated louvres in an SUV design

Suspension with steel springs

TIREFIT



GLE

AMG Line interior

AMG floor mats in black velour with "AMG" lettering

AMG sports pedals in brushed stainless steel with black rubber studs

Nappa Leather Upholstery

Dashboard, door panelling plus armrests in black ARTICO man-made leather

Multifunction sports steering wheel in nappa leather with flattened bottom section

Sports seats for driver and front passenger with specific seat upholstery layout



GLE

AMG Line exterior

20" AMG 5-twin-spoke light-alloy wheels

AMG bodystyling consisting of AMG front apron with chrome trim element and striking sporty air intakes in the wing liners, flared wheel arches at front and rear painted in the vehicle colour, AMG side skirts painted in vehicle colour, AMG rear apron with diffuser-look insert in black and trim strip in chrome

Diamond radiator grille with pins in chrome, integral Mercedes star and single louvre painted in matt iridium silver with chrome insert

Sports braking system with perforated front brake discs and brake calliper trim with "Mercedes-Benz" lettering



GLE

7-Seater package from *€3,058

P64 Memory Package Required + Not available for PHEV

20" 5-spoke light-alloy wheels (Not required with AMG Line)

3rd row of seats for 2 people

Electrically-adjustable 2nd seat row



GLE

Night package from €888 *

20" AMG 5-twin-spoke light-alloy wheels painted in high-gloss black with high-sheen finish

Air inlets in radiator grille and front bumper in high-gloss black

AMG front apron in A-wing design with trim strip in high-gloss black

AMG rear apron with diffuser-look insert in black and trim strip in high-gloss black

Diamond grille with pins in chrome and louvre in high-gloss black

Exterior mirror housings painted in high-gloss black

Heat-insulating dark-tinted glass from the B-pillar

Roof rails in matt black

Windowline trim strip and beltline trim strip in black



GLE

Premium package from €5,405*

MBUX Augmented Reality

Memory package

MULTIBEAM LED

Parking package with 360° camera



GLE

Premium Plus package from €11,278*

MBUX Augmented Reality

Burmester® surround sound system

ENERGIZING package

KEYLESS-GO Comfort package

Memory package

MULTIBEAM LED

Panoramic sliding sunroof

Parking package with 360° camera



GLE

Optional equipment

	From*
AIRMATIC package	€3,996
Aluminium-look, illuminated running boards with rubber studs	€1,387
Anti-Theft Protection package	€1,110
Burmester® high-end 3D surround sound system	€10,879
Burmester® surround sound system	€1,888
Climatised front seats	€1,643
Dashboard and door beltlines in ARTICO man-made leather	€1,998
Driving Assistance package	€1,676
Head-up Display	€2,421
Heated rear seats	€798
Metallic paint	€1,953
MULTIBEAM LED	€2,486
Nappa leather upholstery	€1,332
Panoramic sliding sunroof	€3,552

Smartphone integration (standard on PHEV)	€888
THERMOTRONIC 4-zone automatic climate control	€1,488
Trailer coupling with ESP® trailer stabilisation	€2,130
Wood/leather multifunction steering wheel	€1,311

Wheels

Wheels

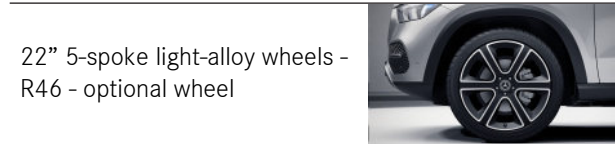
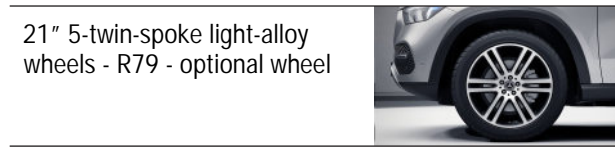
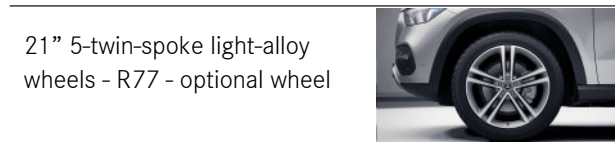
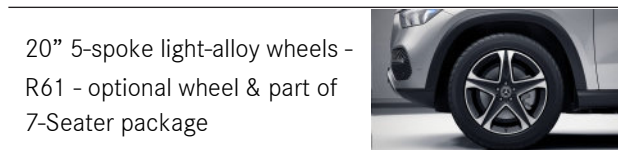
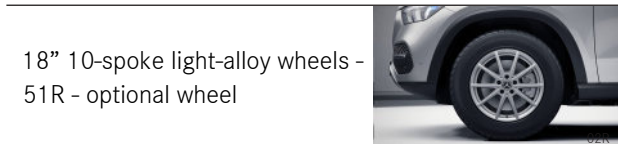
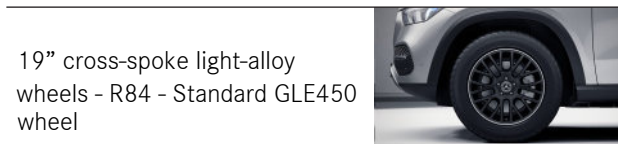
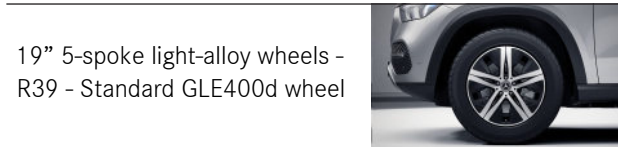
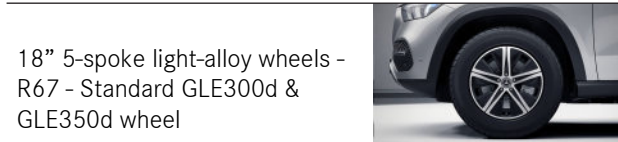

AMG Line wheels

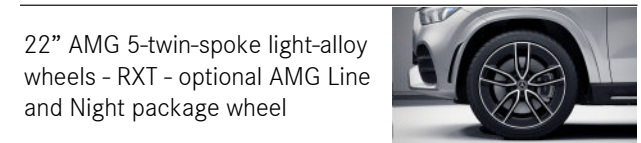
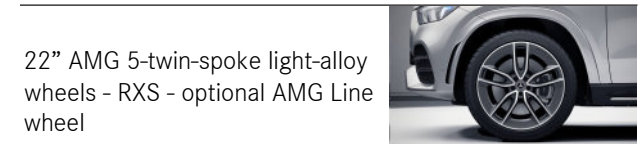
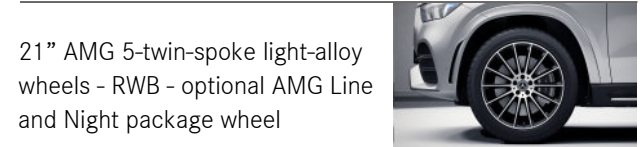
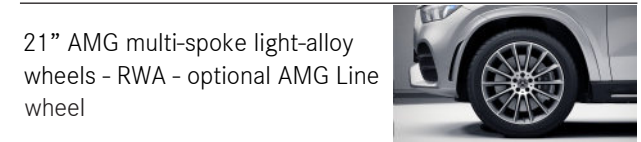
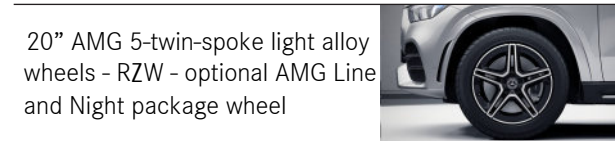

Paintwork

Non-metallic paints

040 black

149 polar white

Metallic paints¹

197 obsidian black

775 iridium silver

859 mojave silver

890 cavansite blue

896 brillant blue

989 emerald green

992 selenite grey

designo paints¹

799 designo diamond white bright

996 designo hyacinth red metallic

¹ Optional extra.

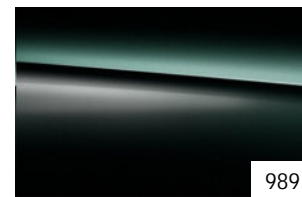
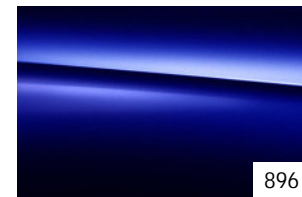
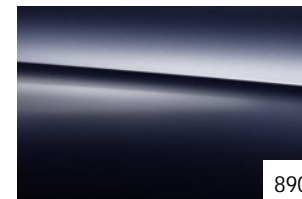
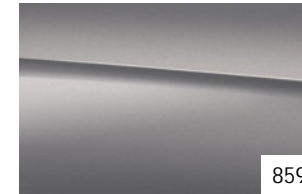
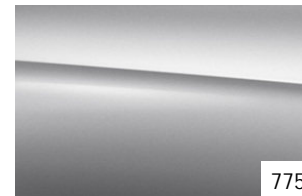
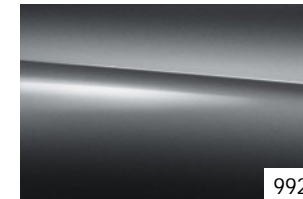
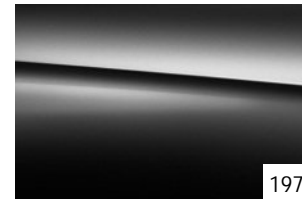
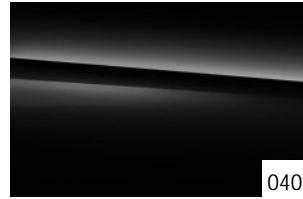

Upholstery and trim

Upholstery

601 ARTICO man-made leather / DINAMICA microfibre - black

201 Rough leather / leather - black

204 Rough leather / leather - espresso brown / magma grey

205 Leather - macchiato beige / black

284 Rough leather / two-tone leather - truffle brown / black

288 Rough leather / two-tone leather - magma grey / black

801 Nappa leather / leather - black

885 Nappa leather / two-tone leather - white / black

958 Nappa leather - magma grey / black

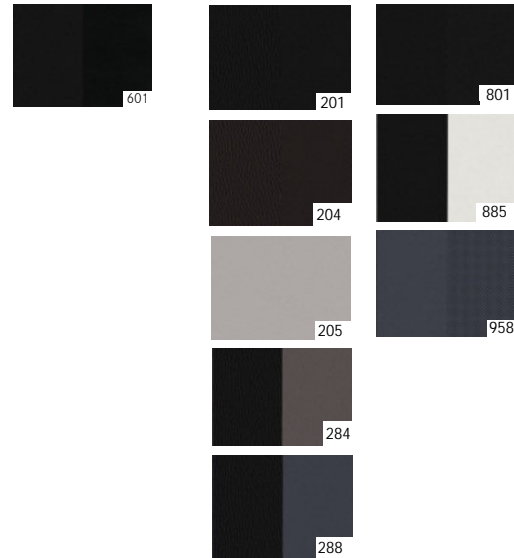

Trim

H18 Trim - High-gloss anthracite lime wood trim

H22 Trim - Brown open-pore walnut wood trim

H31 Trim - Anthracite open-pore oak wood trim elements

H46 Trim - Brushed aluminium trim with light longitudinal grain

H64 Trim - Metal-weave trim

H34 Trim - designo high-gloss brown lightlines lime wood

H35 Trim - designo black flamed open-pore ash wood

H86 Trim - AMG carbon-fibre trim

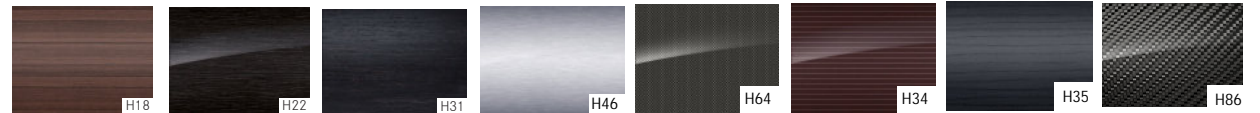

Technical data.

	Diesel engines			Petrol engines
	GLE 300 d 4MATIC	GLE 350 d 4MATIC	GLE 400 d 4MATIC	GLE 450 4MATIC
Displacement (cc)	1950	2925	2925	2999
Rated output ¹ (kW [hp] at rpm)	180 [245] / 4200	200 [272] / 3400 - 4600	243 [330] / 3600 - 4000	270 [367] / 5500 - 6100
Acceleration from 0 to 100 km/h (s)	7.2	6.6	5.7	5.7
Top speed (km/h)	225	230	245	250
Fuel consumption ⁴ (l/100 km)				
Urban	7.3 - 7.0	9.9 - 8.4	9.7 - 8.5	12.6 - 10.5
Extra-urban	5.9 - 5.4	6.0 - 5.6	6.2 - 5.6	7.6 - 6.9
Combined	6.4 - 6.1	7.4 - 6.7	7.6 - 6.8	9.4 - 8.3
Combined CO ₂ emissions ⁴ (g/km)	169 - 161	195 - 177	199 - 179	214 - 190
Emissions class ⁵ /efficiency class ⁶	Euro 6d ISC	Euro 6d ISC-FCM	Euro 6d ISC-FCM	Euro 6d ISC

¹ Information about the rated output according to Regulation (EC) No. 715/2007 in the currently applicable version. ² Available temporarily. ³ Electronically limited. ⁴ The stated figures were determined according to the prescribed measurement method. They constitute the "NEDC CO₂ figures" pursuant to Art. 2 No. 1 Implementing Regulation (EU) 2017/1153. Fuel consumption figures have been calculated on this basis. More information about the official fuel consumption and the official specific CO₂ emissions of new passenger cars is available in the publication entitled "Leitfaden über den Kraftstoffverbrauch, die CO₂-Emissionen und den Stromverbrauch neuer Personenkraftwagen" ["Guidelines concerning the fuel consumption, CO₂ emissions and electricity consumption of new passenger cars"], available free of charge from all retailers and from Deutsche Automobil Treuhand GmbH (www.dat.de). The figures are not based on an individual vehicle and do not constitute part of the product offer; they are provided solely for purposes of comparison between different vehicle models. The figures will vary according to the optional equipment selected. ⁵ Information only valid within the European Union. May vary from country to country. ⁶ Determined on the basis of the measured CO₂ emissions, taking into consideration the vehicle mass. Only valid for Germany. For more technical data, please visit www.mercedes-benz.com

The best for the engine:
Mercedes-Benz genuine engine oils.

Dimensions.

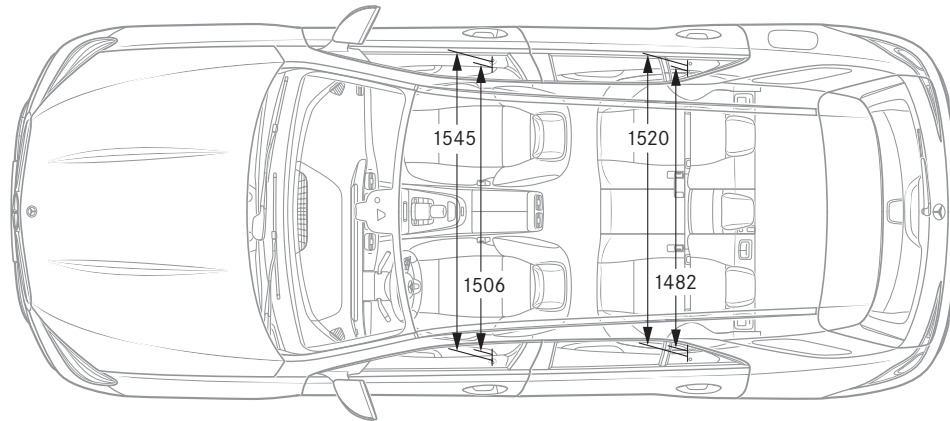
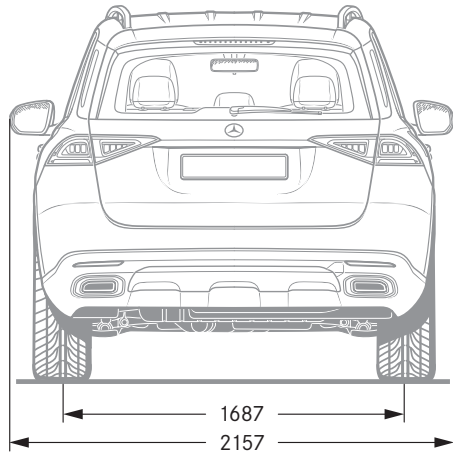
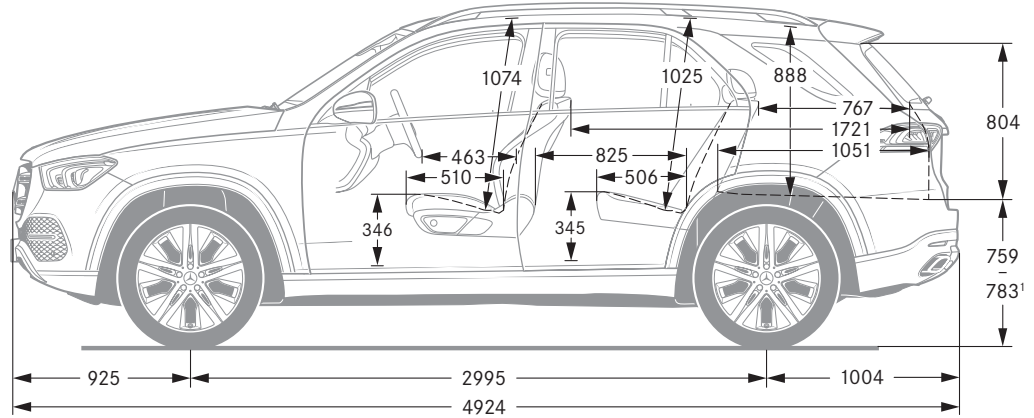
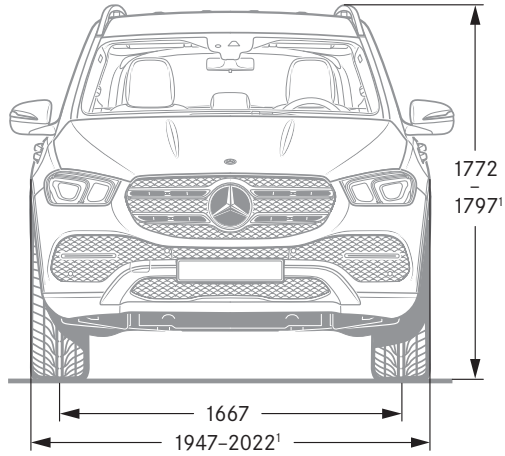

¹ At minimum to maximum height with steel suspension. All figures in millimetres. The illustrated dimensions are mean values. They are valid for vehicles in basic specification and in unladen condition.

Mercedes me

Welcome to your Mercedes-Benz world.

Imagine if ...you could connect with your Mercedes-Benz? With Mercedes me connect, you can! Mercedes me connect offers you new connectivity services that make driving more comfortable and incorporates your car into your personal lifestyle.

Standard Services

- Maintenance Management
- Telediagnosics
- Breakdown Management
- Accident Recovery
- Mercedes-Benz Emergency Call System

Remote Online Services¹

- Remote Retrieval of Vehicle Status (fuel level, tyre pressure etc.)
- Parked Vehicle Locator
- Vehicle Tracker
- Geofencing
- Door lock / unlock function

¹ Can be used with Remote Online special feature.



Getting connected is easy. Just set up your Mercedes me account and get in touch with your Mercedes-Benz dealer to connect your vehicle to your profile to access your Mercedes me connect services.

Contact your dealer to get connected, or go to www.mercedes.me for more details.

Follow us on the following social media channels:

 facebook.com/MercedesBenzIreland

 instagram.com/mercedesbenz_ireland

 [linkedin.com/company/motor distributors ltd](https://linkedin.com/company/motor-distributors-ltd)

 twitter.com/MB_IRELAND

 youtube.com/mercedesbenzireland

 pinterest.com/mercedesbenzire

Motor Distributors Ltd.
Naas Road
Dublin 12
Ireland
www.mercedes-benz.ie

Information correct at time of going to print. Prices and specifications are subject to change without prior notice. Prices quoted do not include dealer and delivery related charges. Images are for illustrative purposes only, actual product may vary. For more specific information in relation to the range of models, features, optional extras, colours and services available please speak to your local authorised Mercedes-Benz dealer.